



STANDALONE COMPUTE UNIT DATA SHEET

PRODUCT OVERVIEW

The CX Standalone compute unit is an all-in-one compute platform, with an integrated touchscreen monitor. Pre-configured for the specific demands of LED control projects to ensure the seamless running of your installations.

The small form factor packs a punch more than capable of driving up to 24 universes of ArtNet control from LED CTRL.

Pre-configured with Debian as the operating system, ensures stability and reliability for continuous running. Additionally, LED CTRL comes installed, configured and ready for action.

LED CTRL is designed to revolutionise your lighting control experience by simplifying the design and commissioning process. It empowers you to plan, test, and configure large-scale projects virtually and collaboratively, ensuring flawless on-site execution.



KEY FEATURES

- LED CTRL 24 UNIVERSE LICENSE INSTALLED
- 10" TOUCHSCREEN DISPLAY
- 2x ETHERNET PORTS
- 2x USB 2.0 PORTS
- 2.4GHZ & 5GHZ DUAL BAND WI-FI AND BLUETOOTH WITH ANTENNA
- TABLE OR WALL MOUNT
- 4G LTE MODULE WITH ANTENNA (JUST ADD YOUR SIM CARD)
- INTEGRATED SUPERCAPACITOR (SHORT TERM BACKUP POWER SUPPLY)



SPECIFICATIONS

SYSTEM

Platform	Raspberry Pi CM4
CPU	Broadcom BCM2711, quad core Arm Cortex-A72 (ARM v8) 64-bit SoC @ 1.5GHz
VPU	H.265(HVEC), up to 4Kp60 encode H.264, up to 1080p60 decode, 1080p30 encode
GPU	OpenGL ES 3.1 & Vulkan 11.0
Memory	4GB SDRAM
Storage	M.2 NVMe SSD 128GB 16GB eMMC Micro SD card (user storage expansion)

PHYSICAL

Ethernet Ports	1x 10/100/1000Mbit/s, 1x 10/100Mbit/s
MicroSD Card Slot	1x (for user data)
SIM Card Slot	1x NanoSIM slot for 4G signal
IO	2x RS485, 2x RS232 Isolated with electrostatic and surge protection
HDMI	1x Type A HDMI 2.1 (4K, 60Hz)
USB 2.0	2x USB 2.0 Type A
MicroUSB	1x (to support flash to eMMC)
Antenna	2x SMA ports connect to 4G and Wi-Fi/Bluetooth antenna
Dimensions	258mm x 172mm x 42mm (WxDxH excluding antennas)
Weight	1.2kg
Installation	Table or wall mount with VESA mount

DISPLAY

Type	Multi-point Capacitive Touch Screen
LCD Size	10.1" TFT
Resolution	1280 x 800
Colours	16.7MB
Active Area	216.56mm (H) x 135.36mm (V)
Viewing Angle (CR>=10)	80° (L/R/U/D)
Multi-touch	10 points
Surface Hardness	6H

POWER

Input Power	9V-36V DC 2pin 3.5mm screw terminal
Power Consumption	24W (Max)
AC Power Adapter	100-240VAC to 12VDC/2A Adapter with optional US/UK/EU/AU plug

THERMAL

Operating Temperature	-20°C to 60°C
Storage Temperature	-25°C to 60°C
Ambient Humidity	5% - 95% (non-condensing)

CERTIFICATIONS

North America	FCC
Europe	CE

WIRELESS

Wi-Fi Bluetooth	2.4GHz & 5GHz dual-band Wi-Fi and Bluetooth with antenna
4G LTE	Global Module Version

DIMENSIONS

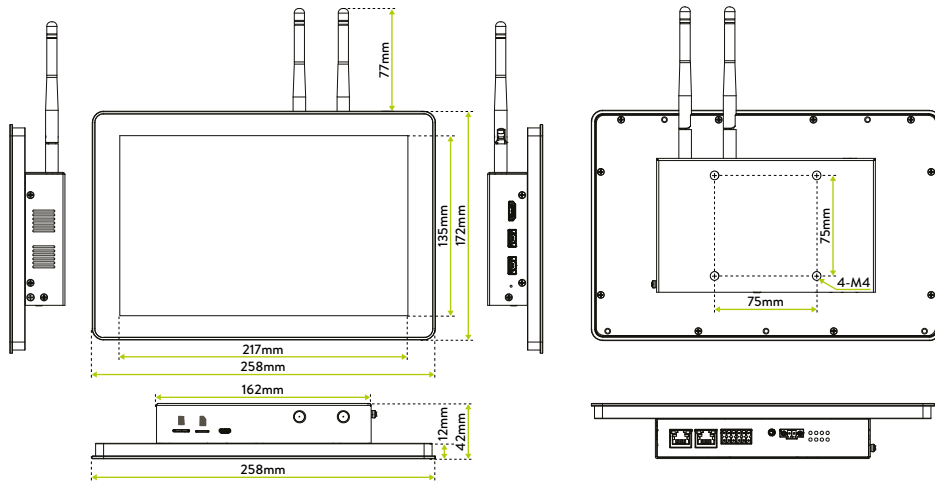

CONFIGURATIONS

- Debian 11 installed
- LED CTRL software installed
- 24 universe LED CTRL license pre-installed
- Auto-boot after power supply failure
- Routine OS updates disabled
- Auto-load last project
- Auto-load of unsaved backups

TYPICAL WIRING DIAGRAM

